

LIMITED WARRANTY

This product is warranted to the original consumer purchaser to be free from defects in materials and workmanship under normal installation, use and service for a period of one (1) year from the date of purchase as shown on the purchaser's receipt.

The obligation of Rolls Corporation under this warranty shall be limited to repair or replacement (at our option), during the warranty period of any part which proves defective in material or workmanship under normal installation, use and service, provided the product is returned to Rolls Corporation, TRANSPORTATION CHARGES PRE-PAID. Products returned to us or to an authorized Service Center must be accompanied by a copy of the purchase receipt. In the absence of such purchase receipt, the warranty period shall be one (1) year from the date of manufacture.

This warranty shall be invalid if the product is damaged as a result of defacement, misuse, abuse, neglect, accident, destruction or alteration of the serial number, improper electrical voltages or currents, repair, alteration or maintenance by any person or party other than our own service facility or an authorized Service Center, or any use violative of instructions furnished by us.

This one-year warranty is in lieu of all expressed warranties, obligations or liabilities. ANY IMPLIED WARRANTIES, OBLIGATIONS, OR LIABILITIES, INCLUDING BUT NOT LIMITED TO THE IMPLIED WARRANTIES OF MERCHANTABILITY AND FITNESS FOR A PARTICULAR PURPOSE, SHALL BE LIMITED IN DURATION TO THE ONE YEAR DURATION OF THIS WRITTEN LIMITED WARRANTY. Some states do not allow limitations on how long an implied warranty lasts, so the above limitation may not apply to you.

IN NO EVENT SHALL WE BE LIABLE FOR ANY SPECIAL, INCIDENTAL OR CONSEQUENTIAL DAMAGES FOR BREACH OF THIS OR ANY OTHER WARRANTY, EXPRESSED OR IMPLIED, WHATSOEVER. Some states do not allow the exclusion or limitation of special, incidental or consequential damages so the above limitation or exclusion may not apply to you. This warranty gives you specific legal rights, and you may also have other rights which vary from state to state.



ROLLS CORPORATION
SALT LAKE CITY, UTAH
7/00

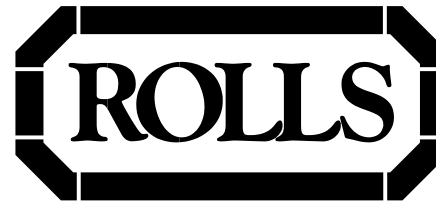

RPQ160 Parametric Equalizer

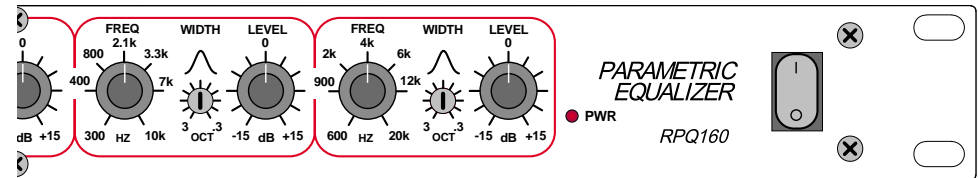
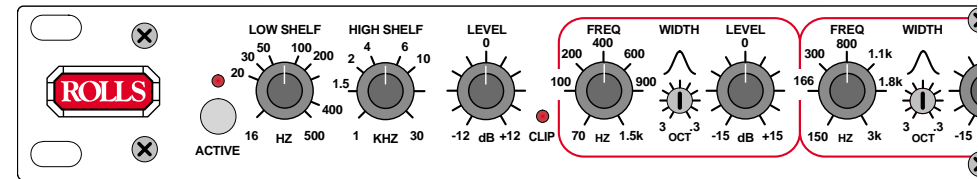

OWNERS MANUAL

INTRODUCTION

Thank you for your purchasing the RPQ160 Parametric Equalizer. The RPQ160 uses T filters for equalization circuits to avoid the complexity and distortion of state-variable filters. The RPQ160 is a four-band parametric equalizer designed for years of reliable use. Please read this manual carefully to get the best results from your RPQ160.

WARNING

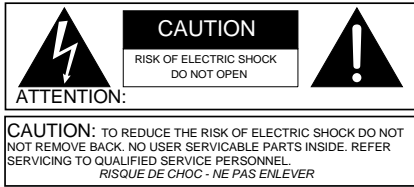

The symbols shown above are internationally accepted symbols that warn of potential hazards with electrical products. The lightning flash with arrowpoint in an equilateral triangle means that there are dangerous voltages present within the unit. The exclamation point in an equilateral triangle indicates that it is necessary for the user to refer to the owners manual.

These symbols warn that there are no user serviceable parts inside the unit. Do not attempt to service the unit yourself. Refer all servicing to qualified personnel. Opening the chassis for any reason will void the manufacturer's warranty. Do not get the unit wet. If liquid is spilled on the unit, shut it off immediately and take it to a dealer for service. Disconnect the unit during storms to prevent damage.

INSPECTION

1. Unpack and inspect the RPQ160 box and package.

If obvious physical damage is noticed, contact the carrier immediately to make a damage claim. We suggest saving the shipping carton and packing materials for safely transporting the unit in the future.

2. Please complete the Warranty Registration Card and return it to the factory.

TABLE OF CONTENTS

Introduction	1	Specifications	6
Warnings	1	Warranty	Back Cover
Inspection	1		
Table of Contents	1		
Description			
Front Panel	2		
Rear Panel	2		
Connection	2		
Operation	3 - 4		
Applications	4		
Schematic	5		

SPECIFICATIONS

CONTROLS MAIN SECTION

Master Level:	-12 to +12 dB
Low Shelf:	16 to 500 Hz High-pass filter
High Shelf:	1 to 30 kHz Low-pass filter
Active Switch:	Activates/bypasses equalization circuitry

CONTROLS FREQUENCY SECTIONS

Frequency Controls:	70Hz to 1.5kHz
	150Hz to 3kHz
	300Hz to 10kHz
	600Hz to 20kHz
Width:	.3 to 3 Octaves each band
Level:	-15 to +15 dB each band

Frequency Response:	16 Hz to 30 kHz +/-3 dB
THD:	<.03%
S/N Ratio:	>90 dB
Max Input:	+22 dB
Max Output:	+22 dB
Input Impedance:	10K Ω (20K balanced)
Output Impedance:	50 Ω
Shelving Slope:	12 dB / Octave
Size:	19" x 6" x 1.75" (48.3 x 15.2 x 4.5 cm)
Weight:	5 lbs. (2 kg)

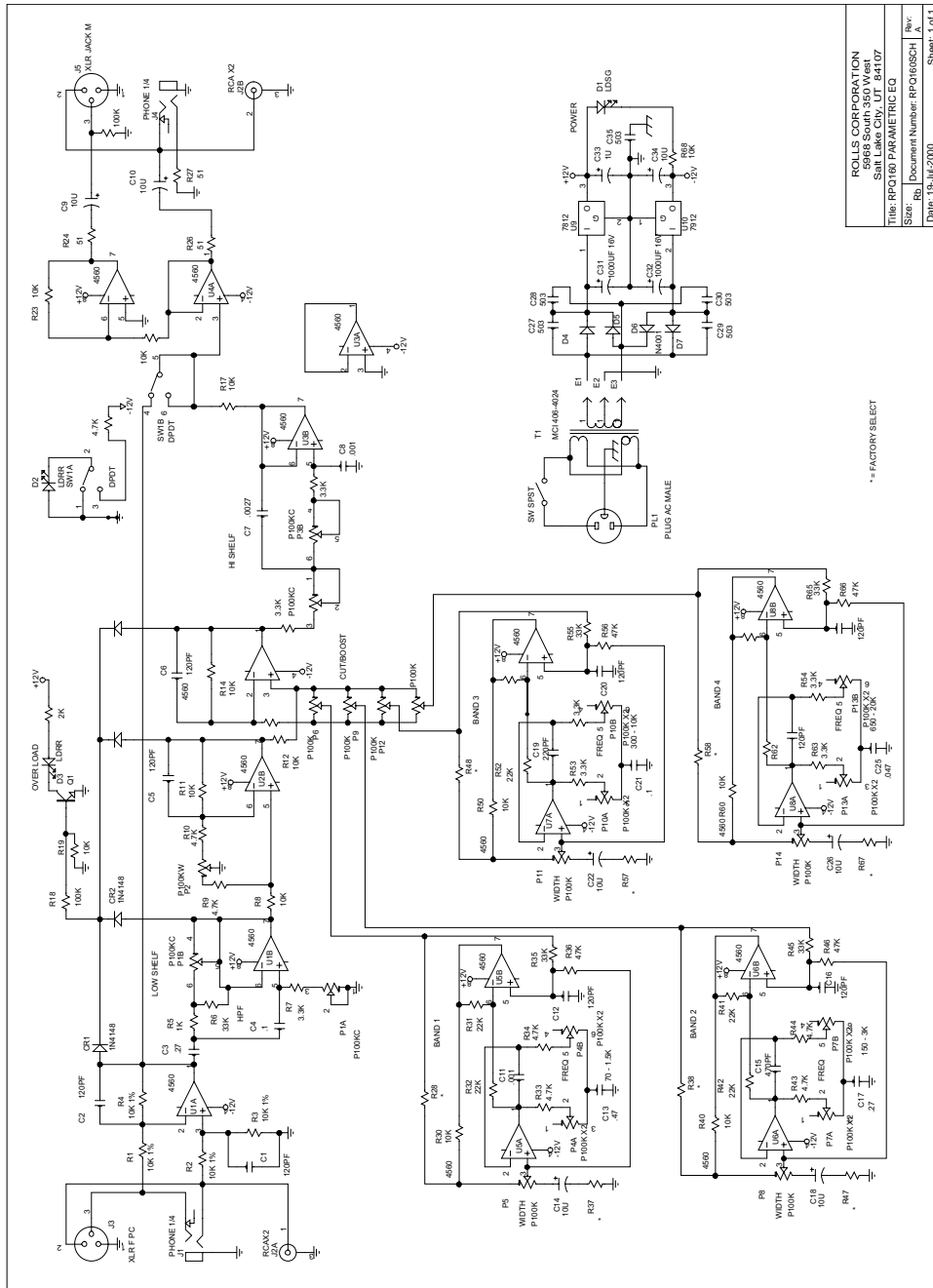

ROLL'S CORPORATION
 3800 SOUTH 3500 WEST AVENUE
 TUCUMCARI, NM 87701
 ITEM: RPQ160 PARAMETRIC EQ
 Size: R8 Document Number: RPQ160SCH Rev: A
 Date: 19-JUL-2000 Sheet: 1 of 1

* FACTORY SELECT

FRONT PANEL

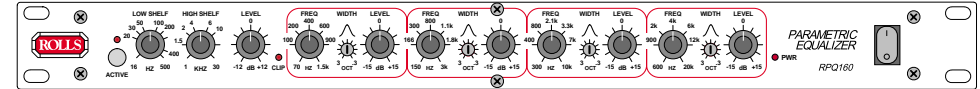

LOW SHELF: High Pass Filter control; adjusts the amount of low frequency rolloff from 500 Hz down to 16Hz for the entire output of the RPQ160.
HIGH SHELF: Low Pass Filter control; adjusts the amount of high frequency rolloff from 1 kHz up to 20 kHz for the entire output of the RPQ160.
NOTE: THERE IS NO BYPASS SWITCH FOR THE LOW OR HIGH SHELF FILTERS - SIMPLY TURN THE LOW SHELF COMPLETELY COUNTERCLOCKWISE, AND THE HIGH SHELF COMPLETELY CLOCKWISE TO BYPASS THESE CIRCUITS.
LEVEL: Adjusts the overall signal level of the RPQ160.

NOTE: The following three descriptions are identical for all four bands of equalization.

FREQUENCY: Selects the frequency to be boost or cut. The band frequency ranges are listed below:

- Band 1: 70 Hz to 1.5 kHz
- Band 2: 150 Hz to 3 kHz
- Band 3: 300 Hz to 10 kHz
- Band 4: 600 Hz to 20 kHz

WIDTH (Q): Varies the shape or width of the equalization being boost or cut from .3 to 3 octaves wide.

LEVEL: Boosts or cuts the signal of the indicated band from -15 to +15 dB.

Power Switch: Applies power to the RPQ160 when the unit is connected to a properly grounded ac outlet. The Power LED will light when the RPQ160 is on.

REAR PANEL



OUTPUT: Balanced XLR and unbalanced 1/4" and RCA jacks for connection to a mixing board, power amplifier or recording device.

INPUT: Balanced XLR and unbalanced 1/4" and RCA jacks for connection to the output of a mixing board, instrument, or other device with the signal to be processed.

CONNECTION

Turn off all equipment before making any connections. Mount the RPQ160 in a properly grounded rack, and make sure the rack is properly ventilated. Ambient temperatures should not exceed 113 degrees F (45 degrees C) when the equipment is in use. Connect your RPQ160 using XLR, RCA or 1/4" connectors. Connect the AC power cord to a properly grounded AC outlet. Route the AC power cord away from audio lines.

The two shelving filters are designed to roll off the frequency response of the signal; the Low Shelf cuts the frequencies 3 dB at the control's indicated setting and rolls off below, and the High Shelf cuts the frequencies 3 dB at the indicated setting and rolls off above. The Low Shelf Sweep Diagram shows the response curve of the Low Shelf filter at its minimum and maximum setting.

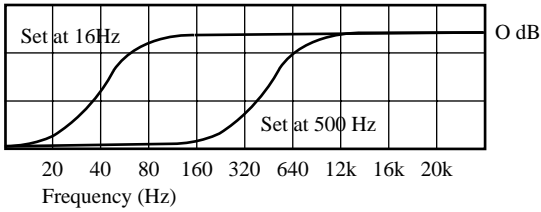

LOW SHELF SWEEP DIAGRAM

The High Shelf Sweep Diagram shows the response curve of the High Shelf filter at its minimum and maximum setting.

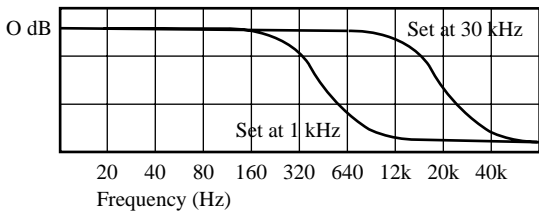

HIGH SHELF SWEEP DIAGRAM

Please note that when the Low Shelf is set fully counterclockwise (16 Hz), the filter is essentially bypassed. Similarly, when the High Shelf control is set fully clockwise (30 kHz), that filter is essentially bypassed.

The Level control has a detente at the center (0 dB) position. If the Clip LED is lighting, the Level control may be turned counterclockwise to reduce the gain of the RPQ160, thereby reducing the clipping. If a weak signal is present, the Level control may be turned up (clockwise) to increase the gain. To achieve the maximum signal to noise ratio, the Level should be set 3 dB below the clipping level. This is done by adjusting the Level control with a normal signal present until the Clip LED lights, then turning the Level down to just below the point when the LED goes out.

Shown below is the typical symmetrical response curve of a swept parametric band filter with the Frequency control set at 1 kHz, the Level set at +15 and -15 dB, and the Octave control set at .3, .5, 1, and 3. These curves remain consistent over the frequency spectrum, they simply shift to whatever frequency setting is indicated by the Frequency control.

The shape is most narrow when the OCT control is set at .3, and is widest at the 3 setting.

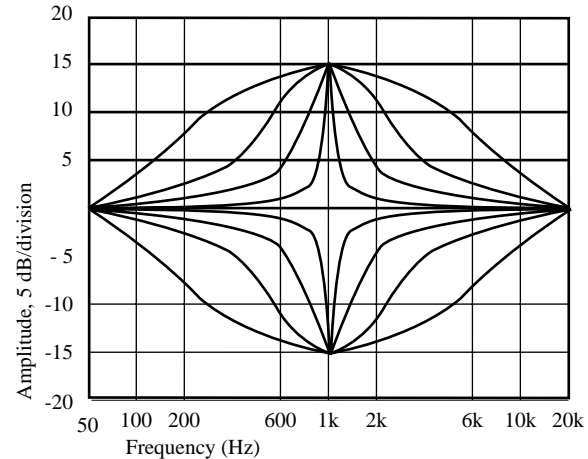

APPLICATIONS

The RPQ160's precise equalization has many applications including school or church gymnasiums, home or professional recording studios, live sound, or musical instruments.

When coupled with a spectrum analyzer, the RPQ160 can match exactly the properties of typical acoustic resonances and reflections, and make immediate improvements to any installed system's amplitude and phase response.

Live applications include equalizing trouble spots where a mix may be muddy, too harsh, flat, and even eliminate feedback precisely without affecting the flavor of the overall sound.

Recording studios benefit from the RPQ160's precise equalization in notching trouble frequencies that remove from a performances musicality, or by sweetening up a final mix.